

OUTDOOR
LIVING
SOLUTIONS



THE CORE outdoor



Since our inception, we have been committed to delivering premium outdoor living systems, designed for style, durability and functionality.

With so many outdoor living contractors in Florida, Virginia, and North Carolina, choosing the right one for your project can be challenging. Thankfully, for homeowners in North Carolina, the choice is clear. By choosing The Core Outdoor for your backyard landscape projects, you partner with a company whose reputation speaks for itself.

When it comes to Bioclimatic Pergolas, Retractable Pergolas, Glass Systems, Awnings, Screens Blinds and the other outdoor living projects, the Key to success is knowledge and experience. Our commitment to knowledge within all phases of a project is the foundation of our business. We give our all, don't cut corners, get the job done right the first time and expect our customers to settle for nothing less.

Products

BIOCLIMATIC PERGOLAS

Automated, remote-controlled, retractable louver roof cover with aluminum profile framework

RETRACTABLE PERGOLAS

Automated remote controlled, retractable acrylic fabric roof cover with aluminum profile framework

FIXED - SLIDING - FOLDING GLAZED FACADE AND ROOF SYSTEMS

Automated, remote- or manual-controlled sliding, folding, or fixed glazed roof and facade panels with aluminum profile framework

Fix Glass Roof Systems

Retractable Glass Roof Systems

Sliding Doors

Vertical Sliding Windows

Folding Doors

SCREENS AND BLINDS

Automated remote or manual controlled acrylic fabric screens and blinds with aluminium profile framework

AWNINGS

Automated remote or manual controlled acrylic fabric awnings with aluminium profile framework





bioclimatique
retractable louver roof
pergola

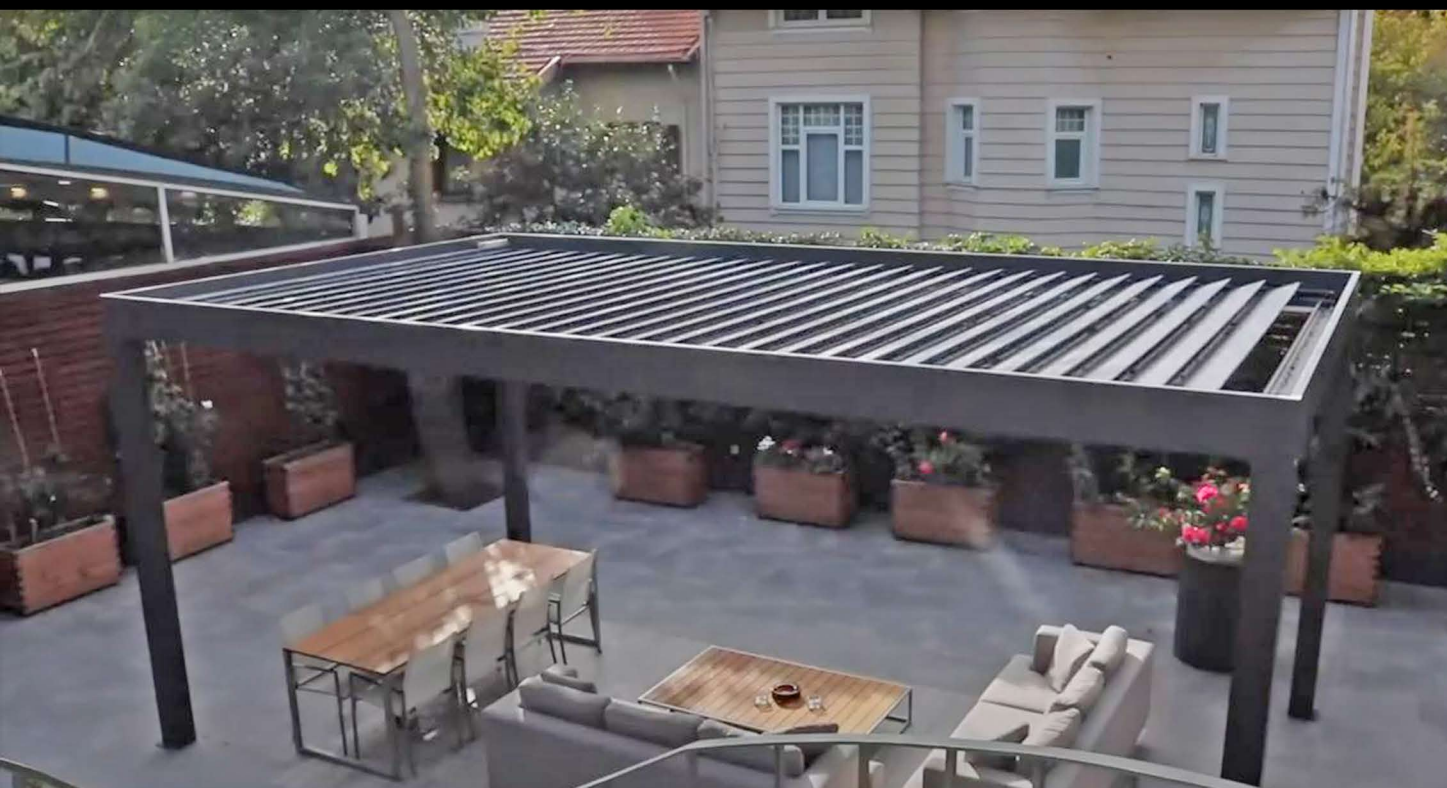

Bioclimatique Retractable Louver Roof

The Ultimate Outdoor Solution

The Bioclimatique Retractable Louver Roof is an advanced aluminum pergola with adjustable, retractable louvers, designed to adapt to any weather condition, including snow.

Suitable for both residential and commercial applications, it provides shade, ventilation, and rain protection, making it a stylish and functional addition to homes, restaurants, hotels, pools, and entertainment spaces.

Year-Round Comfort & Adaptability

This motorized pergola ensures a seamless outdoor experience, allowing users to enjoy their patios, gardens, rooftops, and terraces in any weather. Whether free-standing or wall-mounted, it enhances both aesthetic appeal and functionality, making outdoor spaces more inviting.

What sets our Bioclimatique Retractable Louver Roof apart from competitors in the Charlotte, NC area is its superior flexibility. Unlike other pergolas on the market, which only feature louvers that tilt, our system is fully retractable, offering unparalleled adaptability for users. This unique feature ensures that users have the freedom to open their outdoor space entirely, partially, or close it fully to suit their needs, regardless of weather or occasion.



Advanced Features & Customization

Motorized louver system adjusts via remote control, sensors, or smart home integration for precise sun, shade, and rain protection.

Optional enclosures, such as framed or frameless sliding glass doors, create a controlled, comfortable outdoor room.

Personalized enhancements, including motorized drop awnings, drapes, and curtains, add privacy and protection from sun, wind, and rain.

Superior Engineering & Durability

Corrosion-resistant, powder-coated aluminum guarantees longevity and weather resistance.

Efficient drainage system with a gutter capacity of 0.4 gal/h and 0.009 gal/h water disposal under heavy rainfall.

Wind load tested to withstand over 105 km/h (65 mph) for reliable stability in various climates.

Low-maintenance structure ensures long-term functionality with minimal upkeep.

With its cutting-edge technology, sleek aesthetics, and robust construction, this retractable louvered pergola redefines outdoor living, providing a versatile space for relaxation, dining, and entertainment in both residential and commercial settings.

Structure types



Wall-mounted



Self standing

Complementary products



Screens Enclose your pergola facades with automatic zip screens



Panoramic glass Automatic vertical glass systems efficiently enclose facades



Sliding Doors Sliding glass systems offer a cost-effective facade enclosure



Folding Doors Bi-fold doors are an elegant solution for enclosing your facades

Features



All Weather Conditions

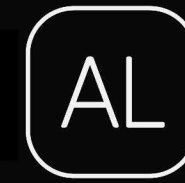

Made Of Aluminium



Automatic System

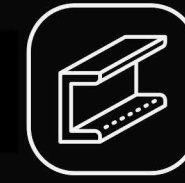

Customizable Dimensions



RAL Color Options



Modern Led Lightings



Stainless Components



Integrated Water Disposal

New Product



Solidroll transparent shutter

Optionals



Censors



Zip Screen Solutions



Glass Facade Solutions



THE CORE
outdoor

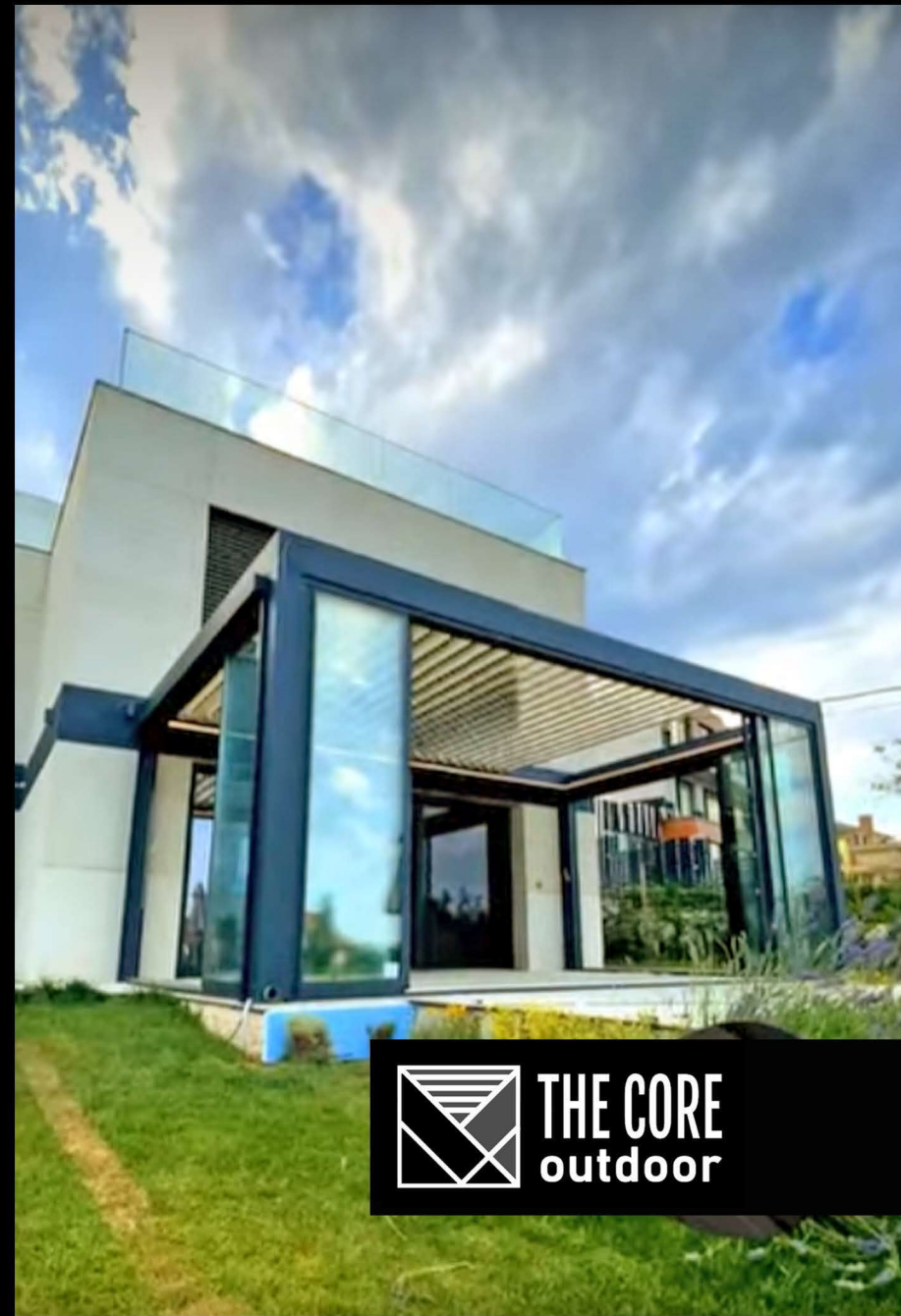

 THE CORE
outdoor



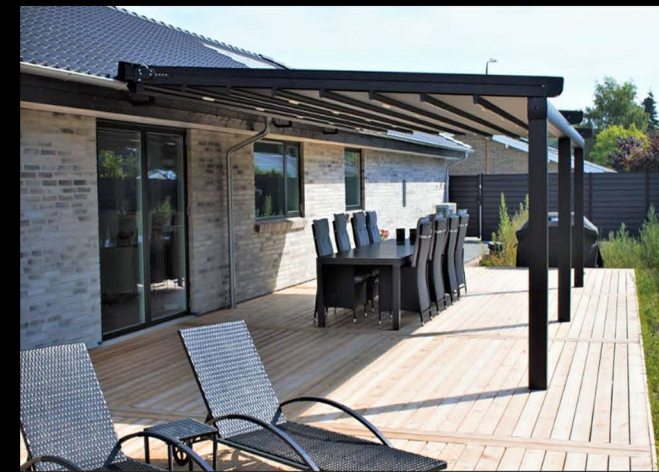

aluminum
retractable fabric roof
pergola



Aluminum Retractable Fabric Roof Pergola

Stylish Comfort in Any Weather

A Retractable Pergola is a stylish outdoor structure with an adjustable, remote-controlled louvered roof for sun and rain protection. Its patented design ensures shade in summer and shelter in winter, while the retractable canopy minimizes storm damage. Available in a selection of standard colors and a wide range of custom options, it allows for seamless personalization to match any outdoor space

Ultimate All-Weather Protection for Year-Round Comfort

Enhance your Retractable Pergola with ceiling fans, lighting, heaters, screens, and a gutter system to create the perfect outdoor retreat for any season. Designed for ultimate comfort, these structures provide excellent sun and rain protection, allowing you to enjoy your outdoor space year-round.

Our premium pergolas feature a durable aluminum frame and weather-resistant composite material, ensuring reliability. The adjustable awning lets you enjoy open skies or stay protected from rain and snow. With customizable sizes, full weather protection, and smartphone control, it combines flexibility, functionality, and convenience.



Advanced Features & Customization

Motorized louver system adjusts via remote control, sensors, or smart home integration for precise sun, shade, and rain protection.

Optional enclosures, such as framed or frameless sliding glass doors, create a controlled, comfortable outdoor room.

Personalized enhancements, including motorized drop awnings, drapes, and curtains, add privacy and protection from sun, wind, and rain.

Superior Engineering & Durability

Corrosion-resistant, powder-coated aluminum guarantees longevity and weather resistance.

Efficient drainage system with a gutter capacity of 0.4 gal/h and 0.009 gal/h water disposal under heavy rainfall.

Wind load tested to withstand over 105 km/h (65 mph) for reliable stability in various climates.

Low-maintenance structure ensures long-term functionality with minimal upkeep

Durable Blockout Fabric for Superior Weather Protection

This pergola system features architectural blockout fabrics made from **high-quality PVC materials**. Designed for durability, blockout fabric is a specialized membrane that effectively blocks sunlight and harsh weather conditions. It comes with a 5-year warranty and meets all international quality standards and certifications, ensuring long-lasting performance and reliability.

Structure types



Wall mounted-suspended straight design



Wall mounted-suspended arch design



Self standing-suspended straight design



Self standing-suspended arch design



Self standing-suspended-double side-straight design



Self standing-suspended-double side-arch design

Complementary products



Screens

Enclose your pergola facades with automatic zip screens



Panoramic glass

Automatic vertical glass systems efficiently enclose facades



Sliding doors

Sliding glasses are economical facade closure solution

Features



All Weather Conditions

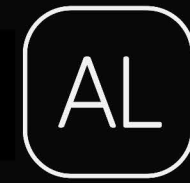

Made Of Aluminium



Automatic System

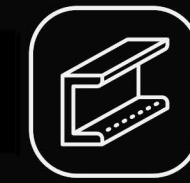

Steel Structure



RAL Color Options



Modern Led Lightings



Flame Retardant

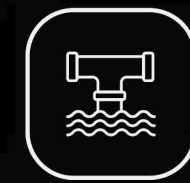

Integrated Water Disposal

Optionals



Censors



Zip Screen Solutions



Glass Facade Solutions



Electrical heater

Structure types



Wall-mounted straight design



Self standing straight design



Wall-mounted arch design



Self standing arch design



Self standing-double side-straight design



Self standing-double side-arch design

Complementary products



Screens

Enclose your pergola facades with automatic zip screens



Panoramic glass

Automatic vertical glass systems efficiently enclose facades



Sliding doors

Sliding glasses are economical facade closure solution

Features



All Weather Conditions

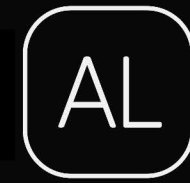

Made Of Aluminium



Automatic System

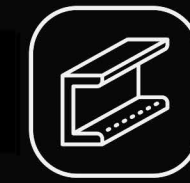

Steel Structure



RAL Color Options



Modern Led Lightings



Flame Retardant

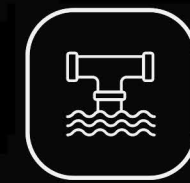

Integrated Water Disposal

Optionals



Censors



Zip Screen Solutions



Glass Facade Solutions



Electrical heater



pepitos
Forth Walton Beach-Florida

Pepito's Fort Walton Beach enhanced the customer experience with its outdoor flex terrace usage. This project featured a self-standing, straight-design retractable pergola. To provide protection from the discomforting effects of the sun, an automated facade screen was integrated.

The pergola's structural and support components were engineered and adapted in compliance with all engineering standards and local codes.

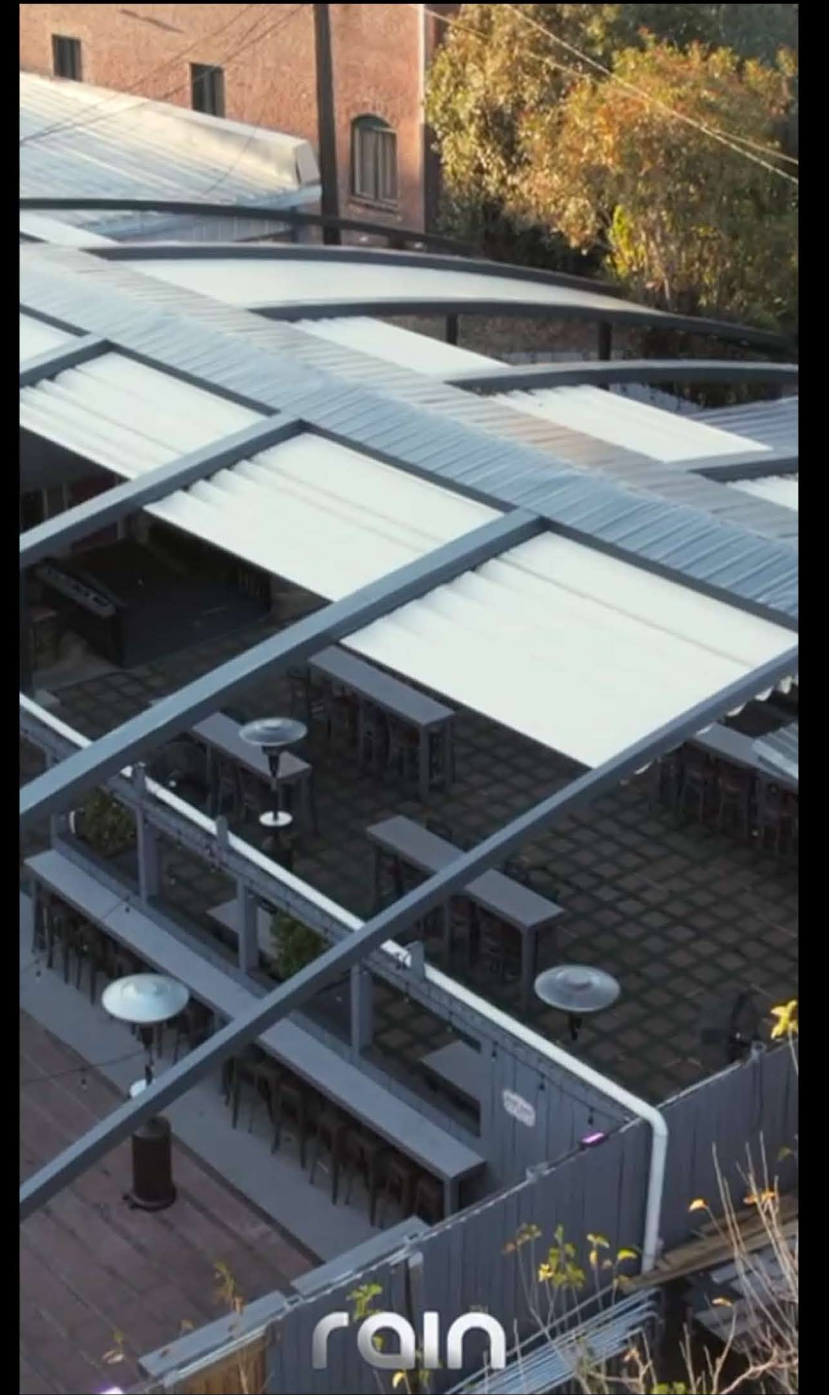

rain
Dothan-Alabama

In our Rain project, we used a self-standing, double-sided arch design retractable pergola. This system was chosen to efficiently cover large open areas in a cost-effective way while allowing flexibility to open the space when desired. It enables the venue to host live performances with minimal impact from weather conditions.

The steel support structure was engineered and tailored to meet the venue's specific requirements and seamlessly integrated with the aluminum system. The pergola was designed and installed in accordance with structural engineering codes, ensuring full compliance with safety standards.



Cost-Effective Aluminum Retractable Fabric Roof Pergola

Our aluminum retractable fabric roof pergola offers a cost-effective, flexible, and high-performance solution for outdoor spaces. Unlike fixed structures, it features a technologically advanced fabric that enhances weather resistance, durability, and ease of use. The automated retractable system allows seamless adjustment, providing optimal protection from sun, rain, and wind while maintaining an open-air feel when desired.

This low-maintenance and energy-efficient design not only ensures long-term savings but also enhances comfort and usability. With its modern aesthetics, adaptability, and affordability, our retractable pergola is the ideal investment for residential patios, commercial terraces, and outdoor recreational spaces.





glass
fixed-sliding
glazed roof-facade
systems

Glass Sunrooms



Enhance Your Outdoor Living with a Premium Glass Sunroom

Create a bright, elegant, and climate-controlled outdoor retreat with a high-quality glass sunroom. Designed for seamless indoor-outdoor living, these fully enclosed spaces offer unobstructed sky views while providing protection from rain, wind, and extreme temperatures—making them ideal for year-round enjoyment.

Crafted with a durable aluminum frame, these structures can be customized with various glass options or sandwich panels to match your aesthetic and functional needs. Modern LED lighting enhances the ambiance, ensuring your space is as beautiful in the evening as it is during the day.

Large glass panels maximize natural light and openness.

Durable aluminum frame with customizable glass or sandwich panel options.

Integrated LED lighting for a stylish and modern ambiance.

Ideal for **winter gardens, verandas, patios, and glass ceilings.**

Complementary products



Screens

Enclose your glass roof facades with automatic zip screens



Panoramic glass

Automatic vertical glass systems efficiently enclose facades



Sliding doors

Sliding glasses are economical facade closure solution

Features



All Weather Conditions

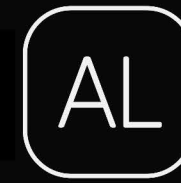

Made Of Aluminium



Automatic System



Modern Led Lightings



RAL Color Options

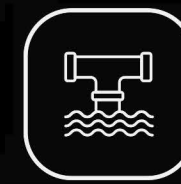

Integrated Water Disposal



Stainless Components

Optionals



Censors



Zip Screen Solutions



Glass Facade Solutions



Steel Structure

Retractable glass roof

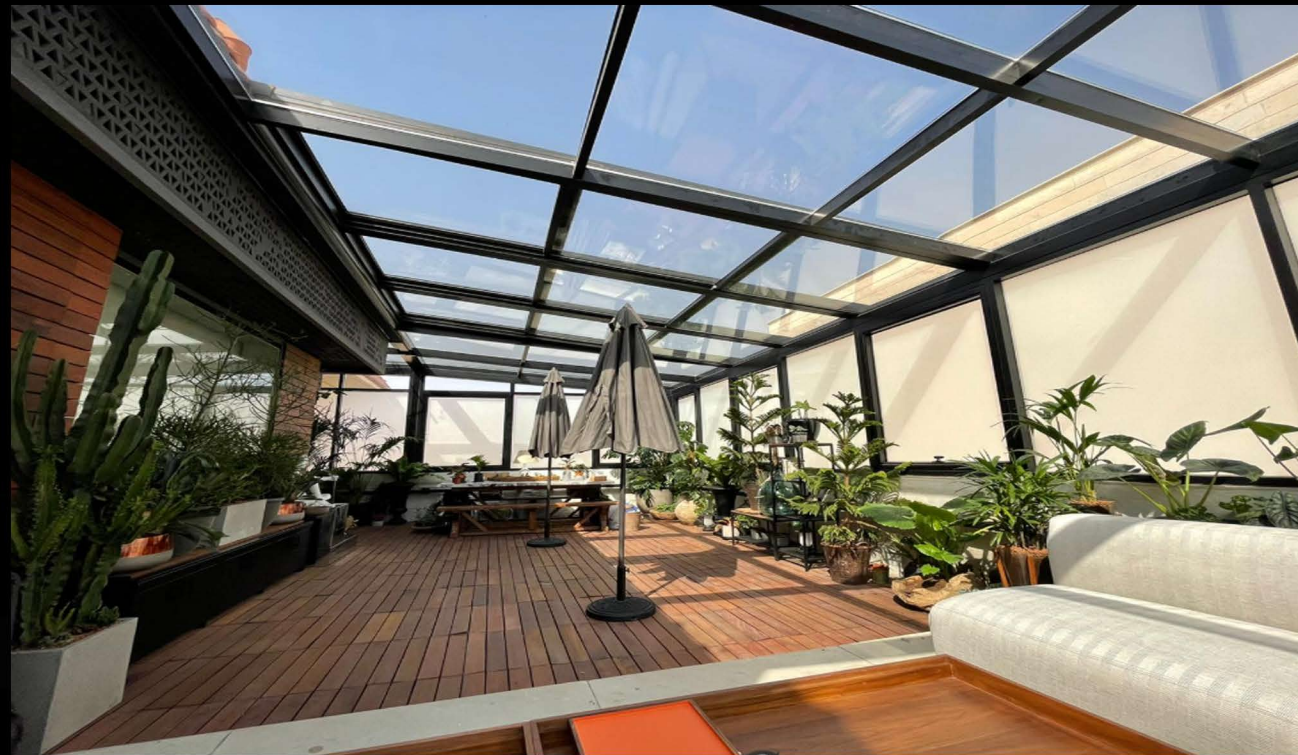

Retractable Glass Roof Elegance Meets Innovation

Combining the elegance of glass with a retractable ceiling design, our retractable glass roof offers an unparalleled experience for those who want to enjoy uninterrupted views of the sky. This luxurious solution provides the benefits of a fully open roof while ensuring complete protection when closed. Effortlessly open or close your glass roof at any time to suit your preferences.

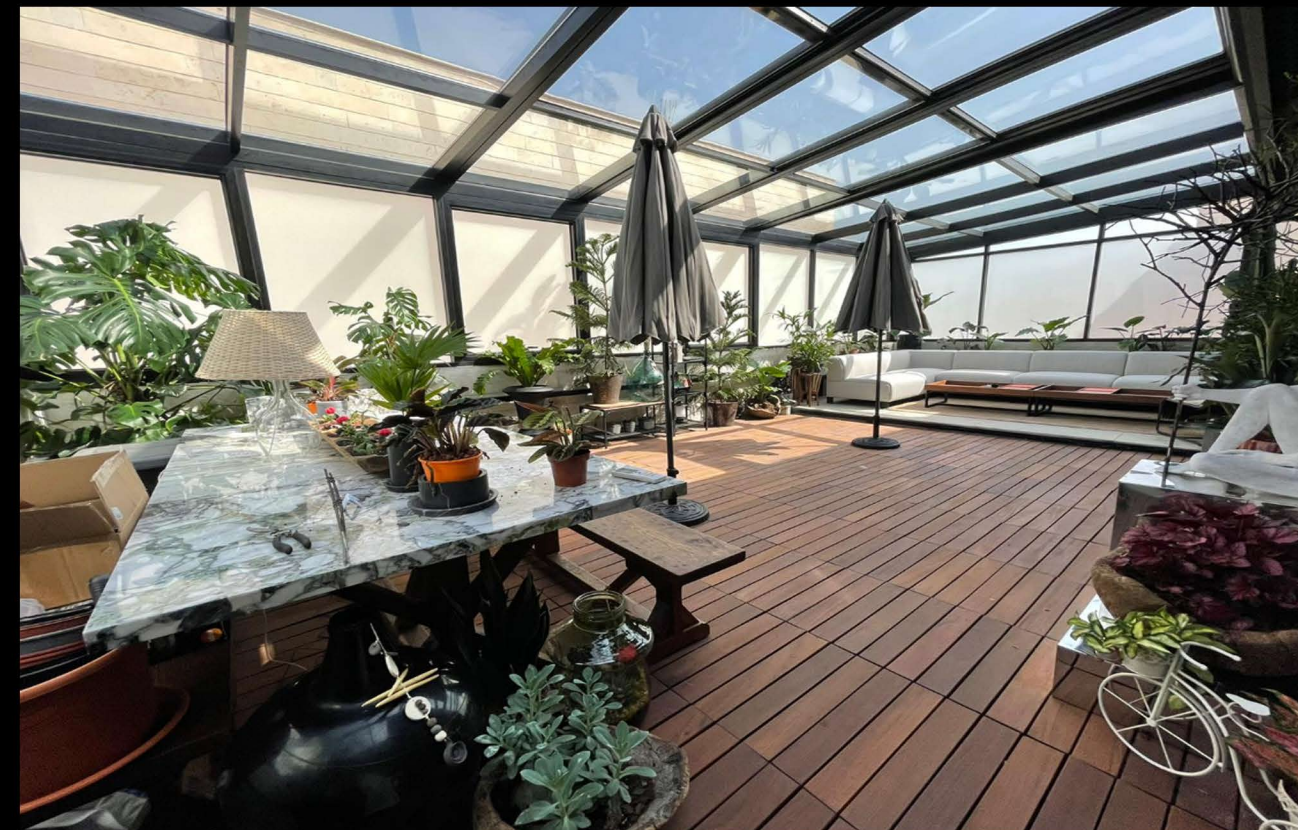

Our retractable glass roof stands out with its cutting-edge technological innovation, featuring remote operation and seamless control for ultimate convenience. Constructed with extruded heavy-duty aluminum profiles, it delivers exceptional durability and stability. The roof is equipped exclusively with double-glazed glass, ensuring superior insulation and a sleek, modern appearance.

Elevate your space with a retractable glass roof—where advanced functionality meets timeless elegance.

Complementary products



Screens

Enclose your glass roof facades with automatic zip screens



Panoramic glass

Automatic vertical glass systems efficiently enclose facades



Sliding doors

Sliding glasses are economical facade closure solution

Features



All Weather
Conditions

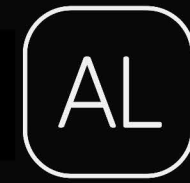

Made Of
Aluminium



Automatic
System



Modern Led
Lightings



RAL Color
Options

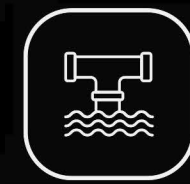

Integrated Water
Disposal



Stainless
Components

Optionals



Censors



Zip Screen
Solutions



Glass Facade
Solutions

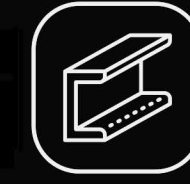

Steel
Structure

Sliding doors



Sliding Glass Systems Versatile, Elegant, and Functional

Sliding glass systems are designed to move horizontally and stack neatly on the sides, adapting seamlessly to any space. With their user-friendly functionality and sleek, modern design, they offer a versatile solution for a wide range of applications.

These systems provide reliable protection in all weather conditions while allowing each panel to slide left or right independently. This flexibility creates a sense of openness and elegance, giving users the freedom to customize their space while enjoying a bright and spacious environment.



Single glazing
5/16-inch or 3/8-inch tempered single glazing options are available.

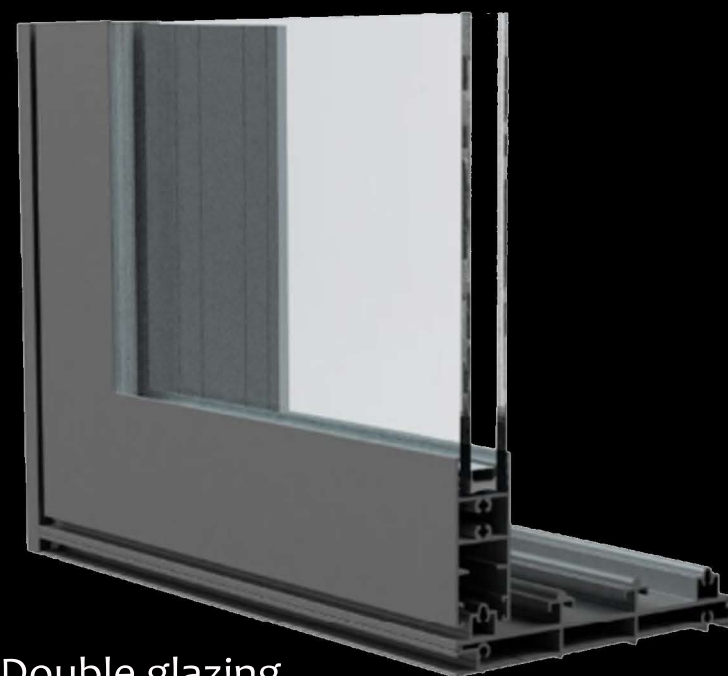

Double glazing
7/8-inch standard or comfort-type double glazing options are available.

Installation options

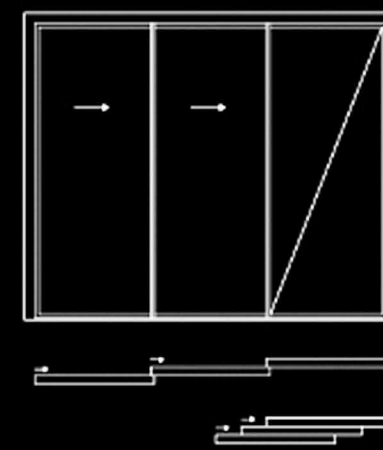

Standard

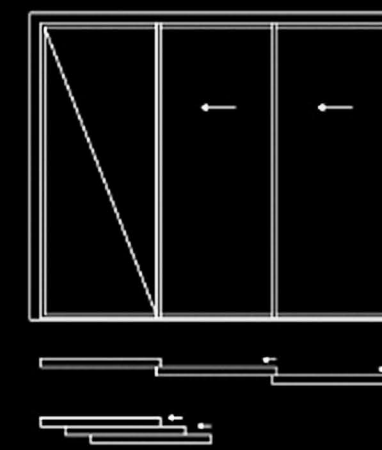

Right and left sliding options

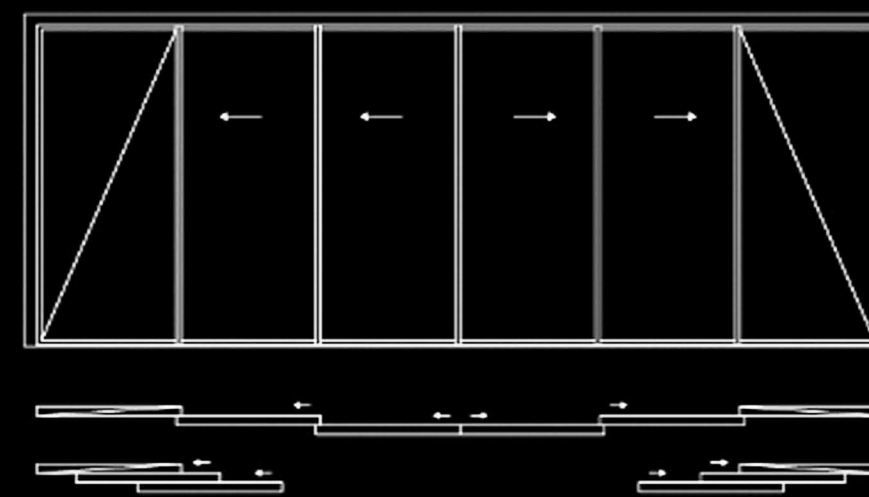

Telescopic

Middle to right and left options

Features



All Weather
Conditions



Made Of
Aluminium



RAL Color
Options



Stainless
Components



Vertical sliding windows



Automated Vertical Sliding Windows

This innovative glass facade solution features automatic, remote-controlled glass panels that provide an uninterrupted panoramic view, combining modern technology with sophisticated design.

With its dynamic structure, it allows users to enjoy expansive views without any visual barriers. Designed for maximum comfort and ease of use, it enhances the connection to nature while complementing any space with a sleek design and a wide range of color options, ensuring seamless integration into various architectural styles.

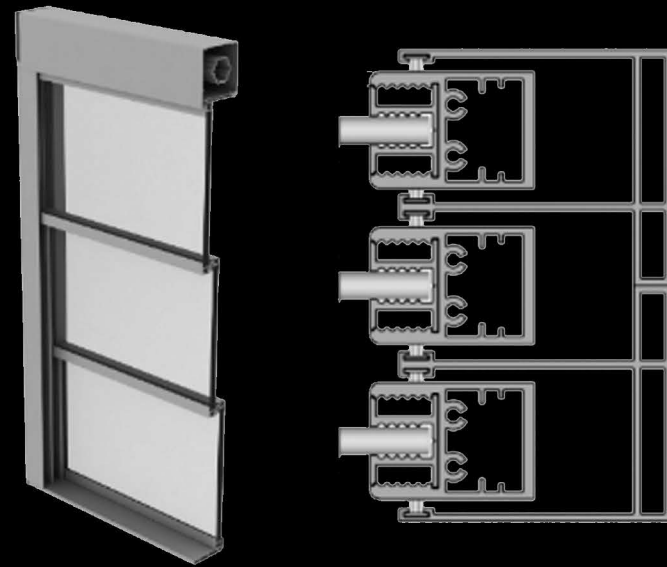

Single glazing

5/16-inch or 3/8-inch tempered single glazing options are available.

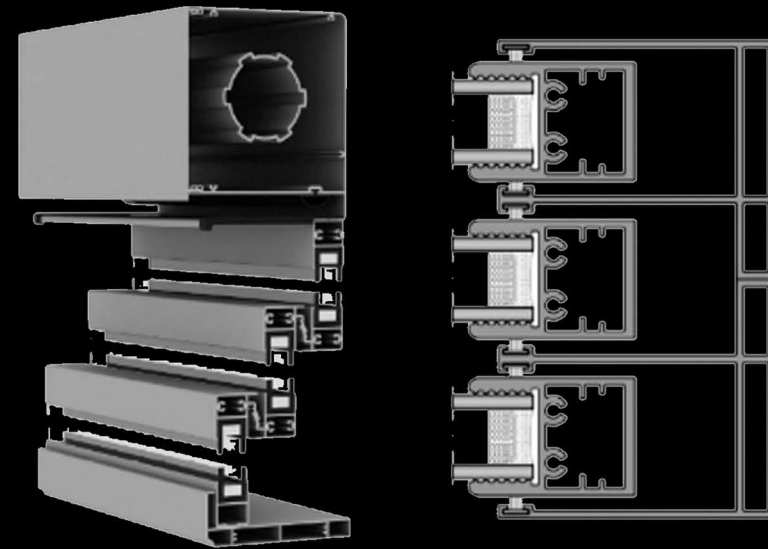

Double glazing

7/8-inch standard or comfort-type double glazing options are available.

Installation options

3 panels option

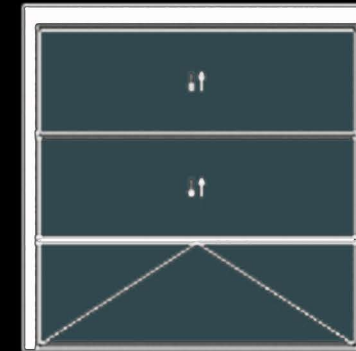

2 panels option

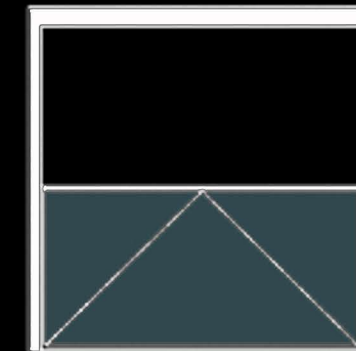
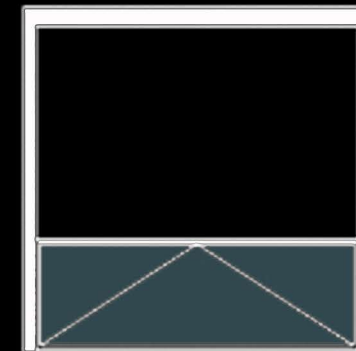
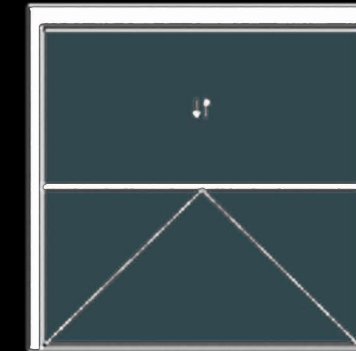

Features



All Weather Conditions

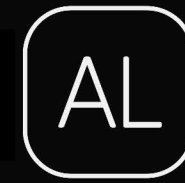

Made Of Aluminium



RAL Color Options



Stainless Components



Folding doors



Sliding Glass Systems Versatile, Elegant, and Functional

Folding glass systems, distinguished by their innovative designs, are engineered to seamlessly adapt to various architectural spaces and settings. With a wide range of applications and customizable color options, these systems blend effortlessly into any environment.

Standard folding glass panels or bi-folding doors, also known as accordion glass systems, operate on a smooth horizontal movement mechanism. The panels can be stacked on one or both sides, allowing for a flexible transition between open and enclosed spaces. This design ensures effortless operation, providing the convenience of transforming spaces at any moment.

Suitable for residential and commercial spaces—including homes, offices, restaurants, and cafes—these durable systems offer maximum protection against various weather conditions. Their robust structure ensures year-round functionality, making them an ideal solution for both indoor and outdoor use.

Structural details

Standard

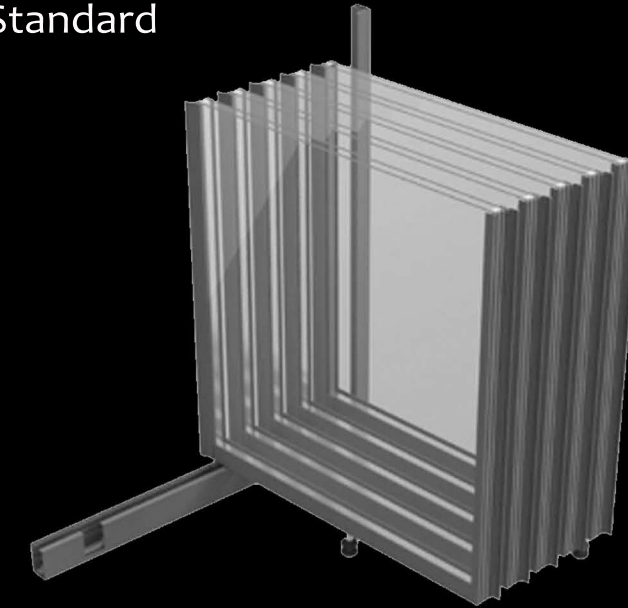

Standard economical system with single options double glass options

Bi-folding



Accordeon function system with only double glaze option

Features



All Weather Conditions



Made Of Aluminium



RAL Color Options



Stainless Components



Screens



Zip Screens

Modern Shading and Climate Control for Every Season

Zip Screens are a popular choice due to their aesthetic appeal, stylish design, and sleek appearance. This curtain system operates using a mechanism with two rails that run within side channels. It is specifically designed to protect against intense solar energy during summer and to help create an ideal indoor climate year-round.

The aluminum frame of the Zip Screen is built to endure the climatic conditions of all four seasons. Additionally, it contributes to energy efficiency by providing temperature control, delivering significant benefits to users.

Zip Screens are operated via remote control and are available in colors that complement both indoor and outdoor spaces, seamlessly adapting to any architectural style. While special screen fabrics are the standard material for this system, they can also be produced with transparent mica PVC for added versatility.

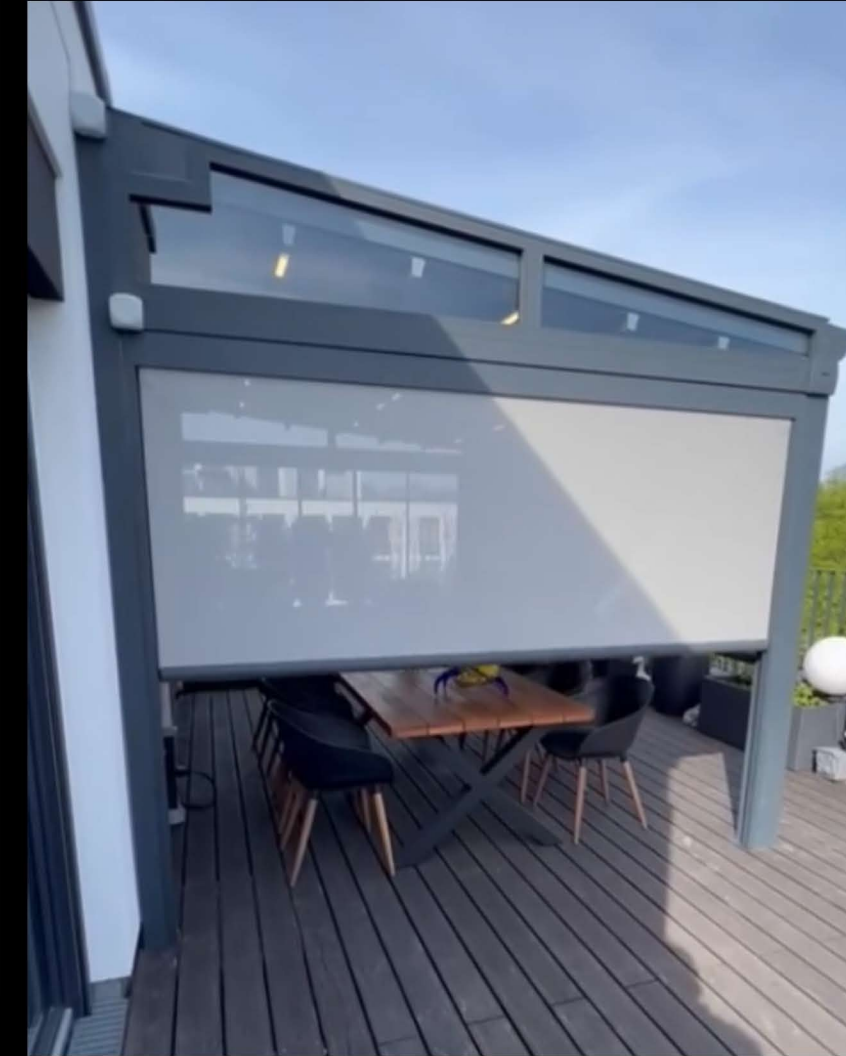

Features



All Weather Conditions

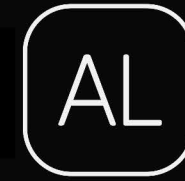

Made Of Aluminium



RAL Color Options



Stainless Components

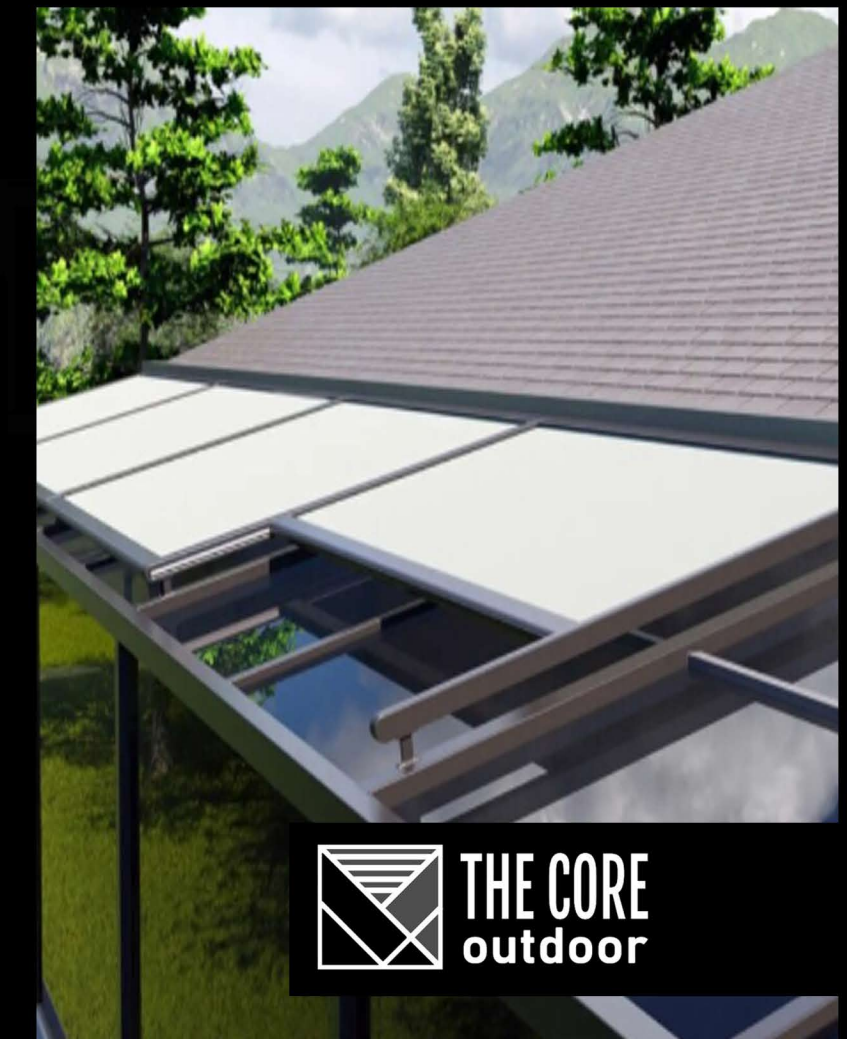

Awnings



Awnings

A Perfect Blend of Style and Practicality

Modern awnings combine sophistication, efficiency, and creativity to transform outdoor spaces, providing shade, comfort, and protection. With compact, refined designs, they turn homes, offices, gardens, and commercial areas into visually appealing and highly functional environments.

Built for resilience, these awnings feature premium materials like aluminum frames and steel components, ensuring long-lasting performance with minimal upkeep. Their fabric, safely stored in protective casings, remains shielded from the elements, prolonging its usability. Equipped with optional motorized controls, lighting, and sensors, they adapt effortlessly to user preferences, offering convenience and versatility.

Customization is a key feature, with a wide variety of fabric patterns and color options available to match any aesthetic. Adjustable angles and mobility features provide flexibility, while their compact design saves space and complements the overall appearance of the area. Whether shading large areas or adding refinement to outdoor spaces, modern awnings deliver a stylish, reliable, and affordable solution for all applications.



Features



All Weather Conditions

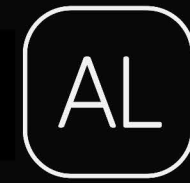

Made Of Aluminium



RAL Color Options



Stainless Components



Flame Retardant

Optionals



Censors



Modern Led Lightings



Automatic System



Electrical heater

OUTDOOR
LIVING
SOLUTIONS



THE CORE
outdoor

 **Address:** Enter On Dillard's Side Of Southern Lion Building, 11033 Carolina Pl Pkwy Ground Floor, Pineville, NC 28134

 **Phone:** (980) 418-3845

 **E-Mail:** info@thecoredesignbuild.com

 **Web:** www.thecoreoutdoornc.com